

Quicke

Member of JOST World

BoH Reference Guide

Bolt on Hooks

2024-05-13

A-Frame					
Interface	No.	A (Inner)	B (Ø)	C (Ø)	D (C-C)
Rail					
40x80/80x80	11256216X	847 mm 33.3 in			
80x80 XL					
M24					
M16 S					
M16 L	11256217X				

According SS-ISO 11001-2:2005

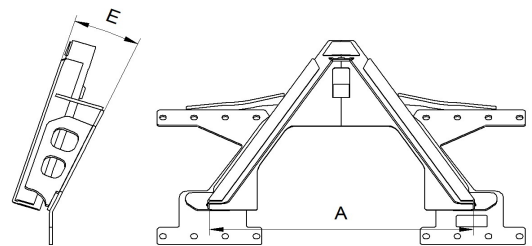

Avant					
Interface	No.	A (Inner)	B (Ø)	C (Ø)	D (C-C)
Rail					
40x80/80x80	11256182X	510 mm 20.1 in	22 mm 0.87 in	25 mm 0.98 in	211 mm 8.31 in
80x80 XL					
M24					
M16 S	11255578X				
M16 L					

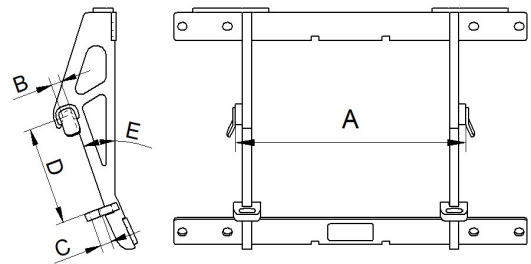

Atlas/Weycor 35					
Interface	No.	A (Inner)	B (Ø)	C (Ø)	D (C-C)
Rail					
40x80/80x80	11256501X	514 mm 20,24 in	36 mm 1.42 in	36 mm 1.42 in	310 mm 12.20 in
80x80 XL					
M24					
M16 S					
M16 L	11256502X				
M16 L	11256503X				

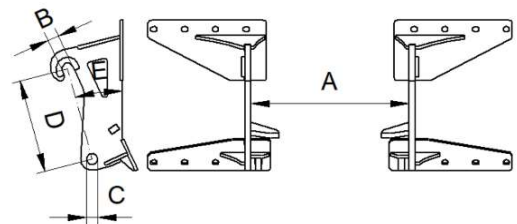

Atlas/Weycor 65					
Interface	No.	A (Inner)	B (Ø)	C (Ø)	D (C-C)
Rail					
40x80/80x80	11256499X	946 mm 37,24 in	41 mm 1.61 in	41 mm 1.61 in	310 mm 12.20 in
40x80/80x80	11256500X				
80x80 XL					
M24	11256506X				
M16 S					
M16 L	11256504X				
M16 L	11256505X				

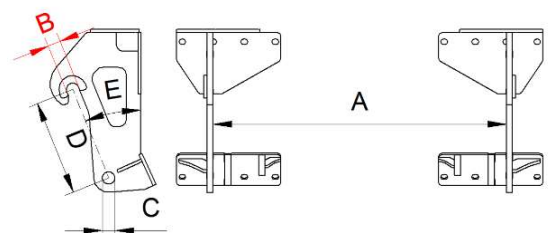

Atlas/Weycor 95					
Interface	No.	A (Inner)	B (Ø)	C (Ø)	D (C-C)
Rail					
40x80/80x80	11256380X				
80x80 XL					
M24	11256536X	946 mm	56 mm	61 mm	380 mm
M24	11256601X*	37.24 in	2.2 in	2.4 in	12.26 in
M16 S					
M16 L					
M16 L					

*Used with implements with grab

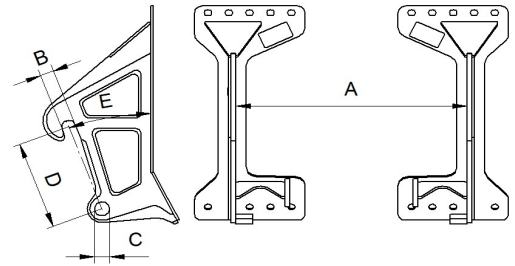

Bobcat / FDI / Massey Ferguson (MF)					
Interface	No.	A (Inner)	B (Ø)	C (Ø)	D (C-C)
Rail	11254112X				
40x80/80x80	11255102X				
80x80 XL	11255221X	765 mm	80 mm	38.25 mm	568.5 mm
M24	11255307X	30.12 in	3.15 in	1.51 in	2.24 in
M16 S					
M16 L	11255632X				

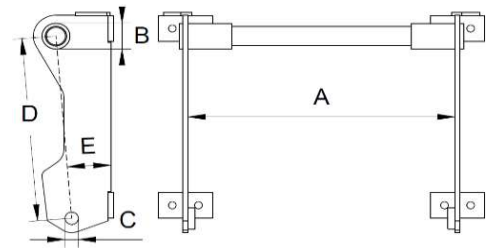

Caterpillar TH					
Interface	No.	A (Inner)	B (Ø)	C (Ø)	D (C-C)
Rail	11255184X				
40x80/80x80	11255142X				
80x80 XL		540 mm	62 mm	52 mm	505 mm
M24	11255269X	21.26 in	2.44 in	2.05 in	19.88 in
M16 S					
M16 L	11255577X				

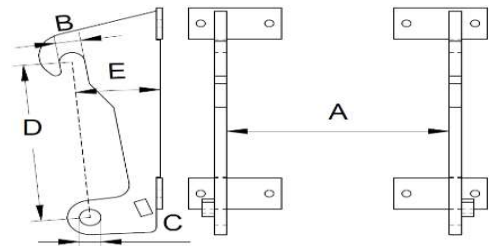

Claas Scorpion					
Interface	No.	A (Inner)	B (Ø)	C (Ø)	D (C-C)
Rail	11254123X				
40x80/80x80	11253575X				
80x80 XL	11255187X				
M24	11255309X	960 mm	51 mm	52 mm	434.5 mm
M24*	11255663X	37.80 in	2.01 in	2.05 in	17.11 in
M24**	11256541X				
M16 L	11255612X				
M16 L***	11255612X				

* Used with buckets

** Used with Powergrab L+ and XL+

*** Used with Powergrab M+ and Multigrab M+

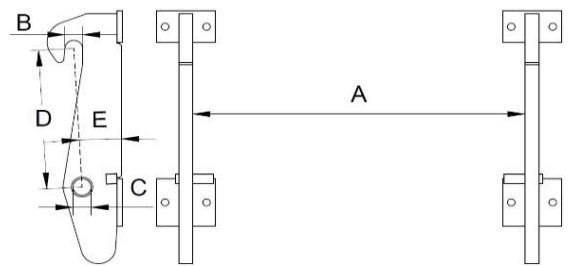

Case New Holland, CNH LM					
Interface	No.	A (Inner)	B (Ø)	C (Ø)	D (C-C)
Rail	11255512X				
40x80/80x80	11255100X				
80x80 XL		765 mm	83 mm	35 mm	349.5 mm
M24	11255511X	30.1 in	3.27 in	13.78 in	1.38 in
M16 S					
M16 L	11255607X				

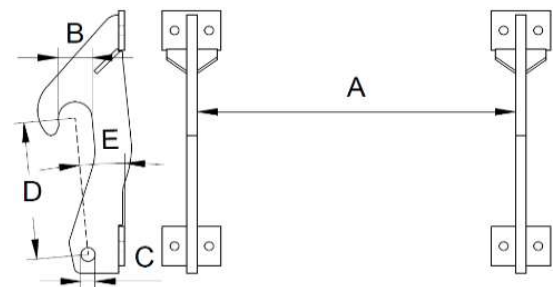

Dieci Small *					
Interface	No.	A (Inner)	B (Ø)	C (Ø)	D (C-C)
Rail	11255238X	620 mm 24.41 in	61 mm 2.40 in	42 mm 1.65 in	482.4 mm 18.99 in
40x80/80x80	11255237X				
80x80 XL					
M24	11255271X				
M16 S					
M16 L	11255629X				

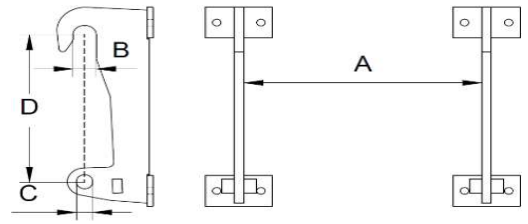

* Dieci models specified on last page

Dieci Medium *					
Interface	No.	A (Outer)	B (Ø)	C (Ø)	D (C-C)
Rail	11255234X	1080 mm 42.52 in	62 mm 2.44 in	44 mm 1.73 in	350 mm 13.78 in
40x80/80x80	11255236X				
80x80 XL					
M24	11255265X				
M16 S					
M16 L	11255628X				

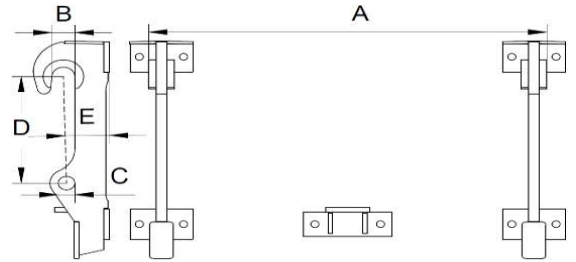

Dieci Large *					
Interface	No.	A (Outer)	B (Ø)	C (Ø)	D (C-C)
Rail	11255098X	1240 mm 48.82 in	62 mm 2.44 in	44 mm 1.73 in	390 mm 15.35 in
40x80/80x80	11255242X				
80x80 XL	11255224X				
M24	11255261X				
M16 S					
M16 L					

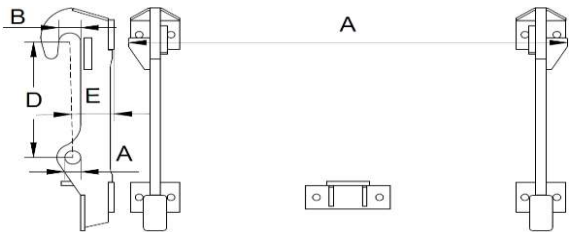

Euro					
Interface	No.	A (Outer)	B (Ø)	C (Ø)	D (C-C)
Rail	11254088X	1080 mm 42.52 in	42 mm 1.65 in	26 mm 1.02 in	299 mm 11.77 in
40x80/80x80	11254377X				
40x80/80x80	11256057X				
80x80 XL	11255324X				
M24	11255468X				
M16 S	11255560X				
M16 L	11255559X				

According to SS-ISO 23206:2005

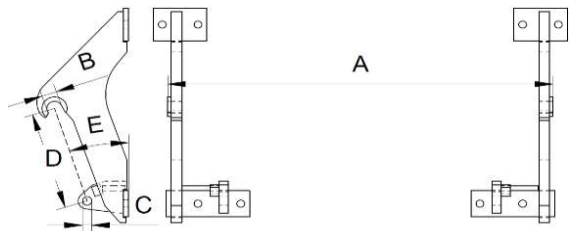

Faucheux White					
Interface	No.	A (Inner)	B (Ø)	C (Ø)	D (C-C)
Rail		915 mm 36 in	47 mm 1.85 in	32 mm 1.26 in	330,5 mm 13.01 in
40x80/80x80	11256197X				
80x80 XL					
M24					
M16 S					
M16 L	11256194X				

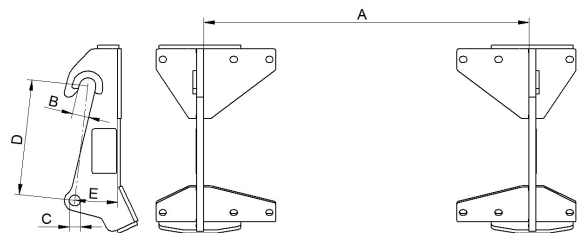

Giant					
Interface	No.	A (Inner)	B (Ø)	C (Ø)	D (C-C)
Rail					
40x80/80x80	11255328X				
80x80 XL		555 mm	41 mm	41,5 mm	310,5 mm
M24		21.85 in	1.61 in	1.63 in	12.22 in
M16 S	11255589X				
M16 L	11255585X				

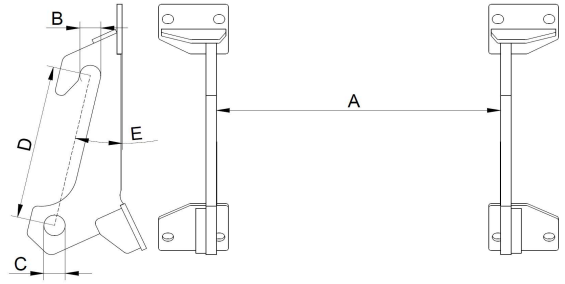

Hauer					
Interface	No.	A (Inner)	B (Ø)	C (Ø)	D (C-C)
Rail	11254366X				
40x80/80x80	11255143X				
80x80 XL		1182 mm	60 mm	30,5 mm	350 mm
M24	11256291X	43.70 in	2.36 in	1.19 in	13.7 in
M16 S					
M16 L	11255631X				

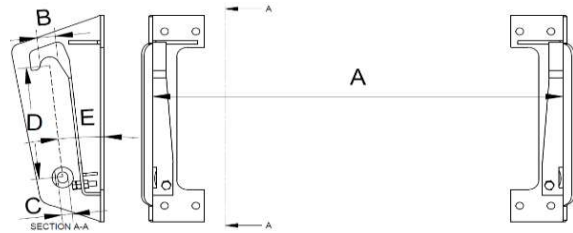

JCB Q-fit					
Interface	No.	A (Inner)	B (Ø)	C (Ø)	D (C-C)
Rail	11254125X				
40x80/80x80	11253571X				
80x80 XL	11255188X				
M24	11255311X	997 mm	60 mm	37 mm	600 mm
		39.25 in	2.36 in	1.46 in	23.62 in
M24 Double hook	11256282X				
M16 S					
M16 L	11255617X				

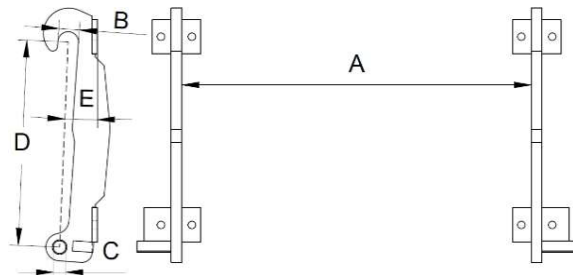

JCB TC Compact					
Interface	No.	A (Inner)	B (Ø)	C (Ø)	D (C-C)
Rail	11255492X				
40x80/80x80	11255141X				
80x80 XL		546 mm	47 mm	45.5 mm	248.5 mm
M24	11255134X	21.50 in	1.85 in	1.79 in	9.78 in
M16 S					
M16 L	11255635X				

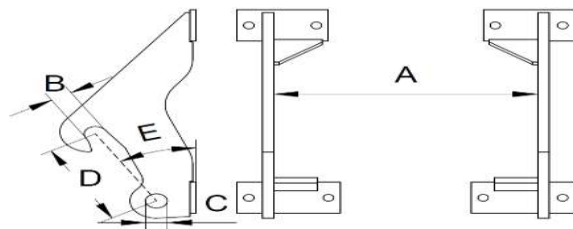

JCB TC					
Interface	No.	A (Inner)	B (Ø)	C (Ø)	D (C-C)
Rail					
40x80/80x80	11256274X				
80x80 XL		500 mm	59 mm	34 mm	490 mm
M24	11256297X	19.70 in	2.3 in	1.3 in	19.3 in
M16 S					
M16 L	11256387X				
M16 L*	11256388X				

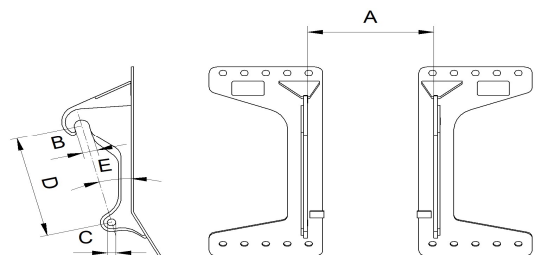

*Used with Multibenne M+, Silograb M+, Manurefork M+

JLG / Deutz Fahr					
Interface	No.	A (Inner)	B (Ø)	C (Ø)	D (C-C)
Rail	11255241X				
40x80/80x80	11255240X				
80x80 XL		734 mm	62 mm	44 mm	399 mm
M24		28.90 in	2.44 in	1.73 in	15.71 in
M16 S					
M16 L					

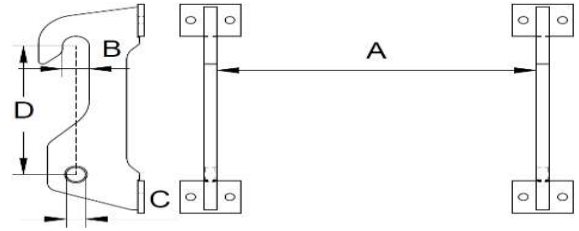

Kramer Compact					
Interface	No.	A (Inner)	B (Ø)	C (Ø)	D (C-C)
Rail					
40x80/80x80	11256068X				
80x80 XL		305 mm	31 mm	31 mm	251,5 mm
M24		12 in	1.22 in	1.22 in	9.9 in
M16 S	11255572X				
M16 L					

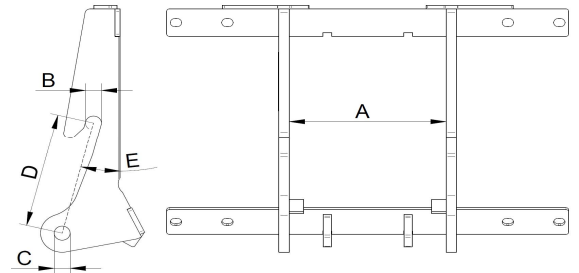

Kramer Short					
Interface	No.	A (Inner)	B (Ø)	C (Ø)	D (C-C)
Rail	11255294X				
Dump out	11255432X				
40x80/80x80	11255368X				
80x80 XL		865 mm	41 mm	41 mm	280 mm
M24	11255274X	34.06 in	1.6 in	1.6 in	11 in
M16 S					
M16 L	11255610X				

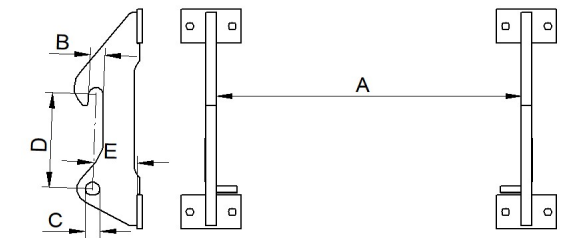

Kramer High					
Interface	No.	A (Inner)	B (Ø)	C (Ø)	D (C-C)
Rail	11255431X				
40x80/80x80	11255415X				
80x80 XL		865 mm	41 mm	41 mm	280 mm
M24	11255413X	34.06 in	1.6 in	1.6 in	11 in
M16 S					
M16 L	11255613X				

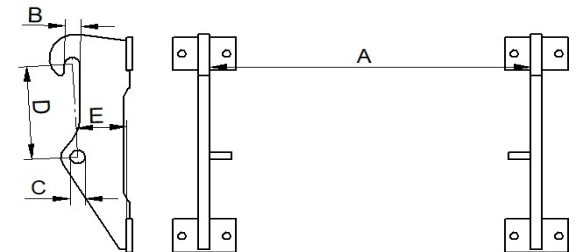

Manitou					
Interface	No.	A (Inner)	B (Ø)	C (Ø)	D (C-C)
Rail	11255273X				
40x80/80x80	11253572X				
80x80 XL	11255189X				
M24*	11255308X				
M24**	11256653X	750 mm	80 mm	35 mm	351 mm
M24***	11256654X	29.53 in	3.15 in	1.38 in	13.82 in
M16 L*	11255623X				
M16 L**	11256651X				
M16 L***	11256652X				

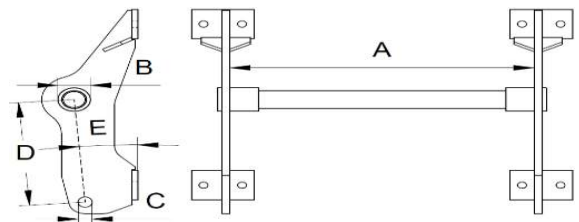

*Used with buckets on Manitou MLT

**Used with buckets on MF and Bobcat. Used with implements with grab on Manitou MLT. Except Silograb M+ and Multibenne M+.

***Used with implements with grab on MF and Bobcat. Except Silograb M+ and Multibenne M+.

Pin and Cone					
Interface	No.	A (C-C)	B (Ø)	C (Ø)	D (under-C)
Rail	11254113X	1068 mm 42.05 in	80 mm 3.15 in	35 mm 1.38 in	370 mm 14.57 in
Rail	11254621X				
40x80/80x80	11253574X				
80x80 XL	11255220X				
M24	11255306X				
M16 S					
M16 L	11255630X				

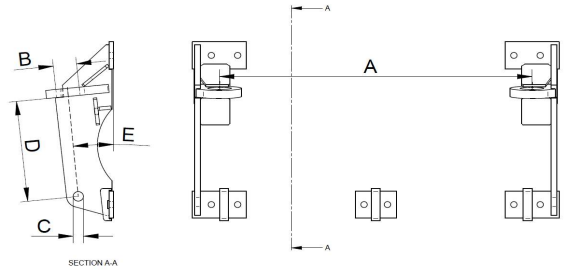

Magni					
Interface	No.	A	B (Ø)	C (Ø)	D (C-C)
Rail		372 mm 14.64 in	70 mm 2.75 in	35 mm 1.37 in	275 mm 10.8 in
40x80/80x80					
80x80 XL					
M24	11256737X				
M16 S					
M16 L	11256738X				

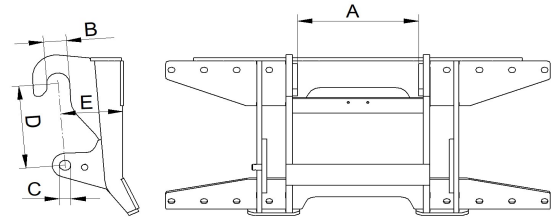

Merlo ZM2S					
Interface	No.	A (Outer)	B (Ø)	C (Ø)	D (C-C)
Rail		695 mm 27.4 in	51 mm 2.0 in	33 mm 1.3 in	384,5 mm 15.14 in
40x80/80x80	11256460X				
80x80 XL					
M24					
M16 S					
M16 L	11256458X				

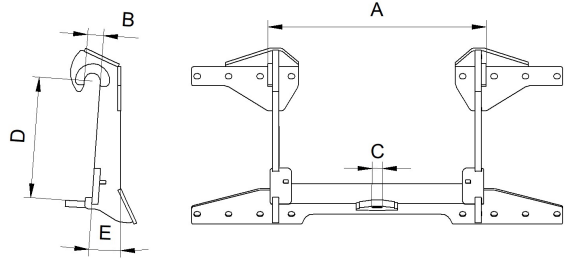

Merlo ZM2					
Interface	No.	A (Outer)	B (Ø)	C (Ø)	D (C-C)
Rail	11255569X	1126 mm 44.33 in	51 mm 2.0 in	35 mm 1.38 in	384,5 mm 15.14 in
40x80/80x80	11253573X				
80x80 XL	11255567X				
M24	11255570X				
M16 S					
M16 L	11255618X				

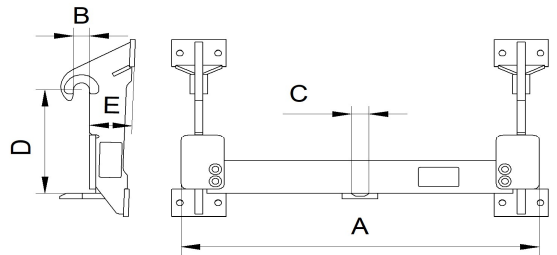

Merlo ZM3 1-pin					
Interface	No.	A (Outer)	B (Ø)	C (Ø)	D (C-C)
Rail	11255096X	1090 mm 42.91 in	52 mm 2.05 in	35 mm 1.38 in	709 mm 27.91 in
40x80/80x80	11255137X				
80x80 XL	11255191X				
M24	11255260X				
M16 S					
M16 L					

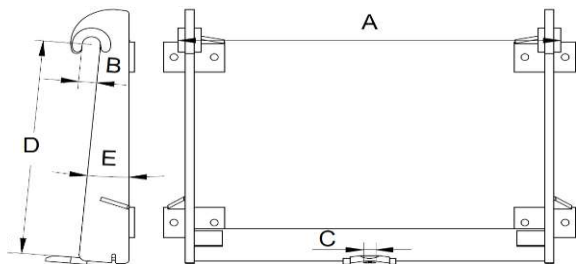

Merlo ZM3 3-pin					
Interface	No.	A (Outer)	B (Ø)	C (Ø)	D (C-C)
Rail	11255095X				
40x80/80x80	11255138X				
80x80 XL	11255190X	1090 mm	52 mm	35 mm	709 mm
M24	11255259X	42.91 in	2.05 in	1.38 in	27.91 in
M16 S					
M16 L					

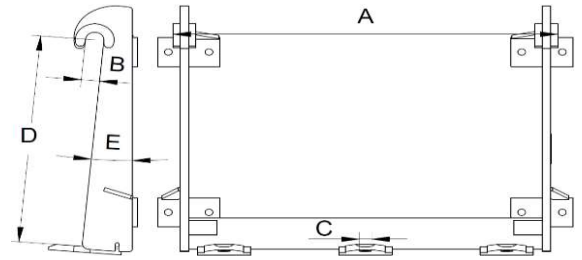

MX					
Interface	No.	A (Inner)	B (Ø)	C (Ø)	D (C-C)
Rail	11254800X				
40x80/80x80	11253971X				
80x80 XL		805 mm	50 mm	33 mm	256.8 mm
M24	11255121X	31.69 in	1.97 in	1.30 in	10.11 in
M16 S					
M16 L	11255622X				

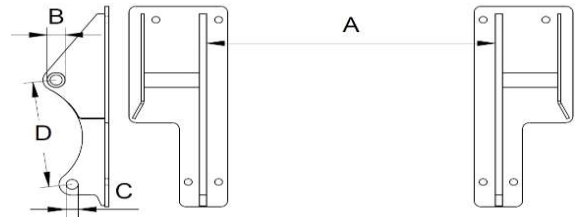

Schäffer Type SWH					
Interface	No.	A (Inner)	B (Ø)	C (Ø)	D (C-C)
Rail	11255233X				
40x80/80x80	11255232X				
80x80 XL		645 mm	41 mm	32 mm	279.5 mm
M24		25.39 in	1.61 in	1.26 in	11.00 in
M16 S	11255561X				
M16 L	11255588X				

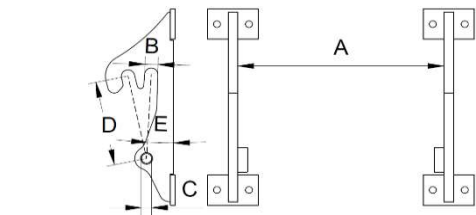

Schäffer Type KR					
Interface	No.	A (Inner)	B (Ø)	C (Ø)	D (C-C)
Rail	11255823X				
40x80/80x80	11255104X				
80x80 XL	11255323X	867 mm	41 mm	42 mm	279.5 mm
M24	11255263X	34.13 in	1.61 in	1.65 in	11.00 in
M16 S					
M16 L	11255593X				

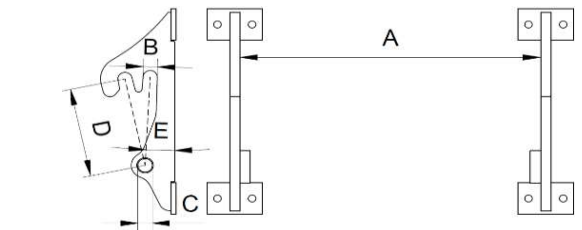

Schäffer VM					
Interface	No.	A (Inner)	B (Ø)	C (Ø)	D (C-C)
Rail					
40x80/80x80	11256163X				
80x80 XL	11256218X	970 mm	61 mm	42 mm	435 mm
M24	11256130X	38.2 in	2.4 in	1.65 in	17.10 in
M16 S					
M16 L					

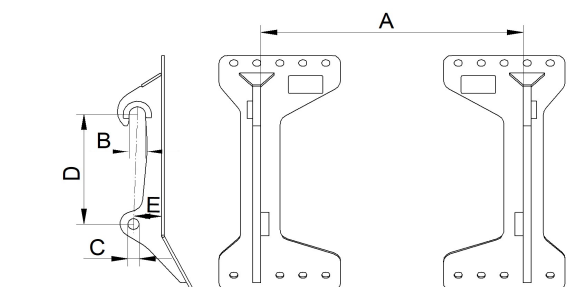

Schäffer Square 336					
Interface	No.	A (Inner)	B (square)	C (Square)	D (top-top)
Rail					
40x80/80x80	11255636X	520 mm 20.47 in	54 mm 1.13 in	54 mm 1.13 in	345 mm 13.58 in
80x80 XL					
M24					
M16 S	11255591X				
M16 L					

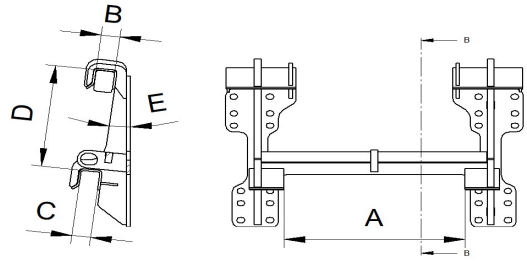

Schäffer Square 442					
Interface	No.	A (Inner)	B (square)	C (Square)	D (top-top)
Rail					
40x80/80x80	11256269X	620 mm 24.4 in	54 mm 1.13 in	54 mm 1.13 in	345 mm 13.58 in
80x80 XL					
M24					
M16 S	11256213X				
M16 L					

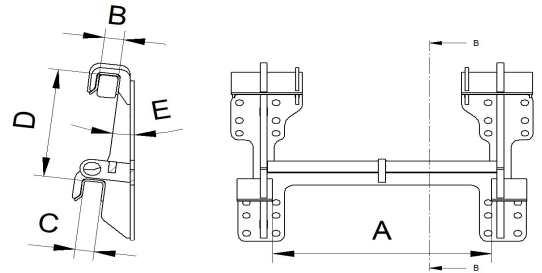

Schäffer HD Square					
Interface	No.	A (Inner)	B (square)	C (Square)	D (top-top)
Rail	11254568X	740 mm 29.13 in	64 mm 2.52 in	64 mm 2.52 in	330 mm 12.99 in
40x80/80x80	11255144X				
80x80 XL					
M24					
M16 S					
M16 L					

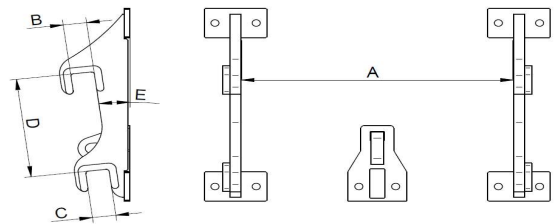

Sennebogen / Fendt					
Interface	No.	A (Inner)	B (Ø)	C (Ø)	D (C-C)
Rail					
40x80/80x80	11256339X	970 mm 38.2 in	71 mm 2.8 in	41 mm 1.6 in	490 mm 19.3 in
80x80 XL					
M24	11256383X				
M24	11256384X*				
M16 S					
M16 L					

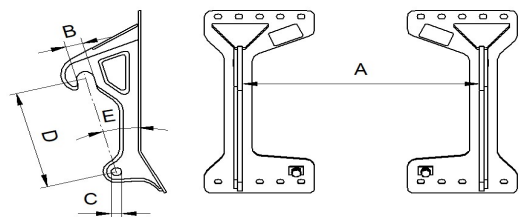

*For implements with grab.

Skid Steer					
Interface	No.	A (Inner)	B (Ø)	C (Ø)	D (C-C)
Rail	11254368X	1132 mm 44.57 in	40 mm 1.57 in	102 mm 4.02 in	422 mm 16.61 in
40x80/80x80	11254498X				
80x80 XL					
M24	11255992X				
M16 S					
M16 L	11255620X				

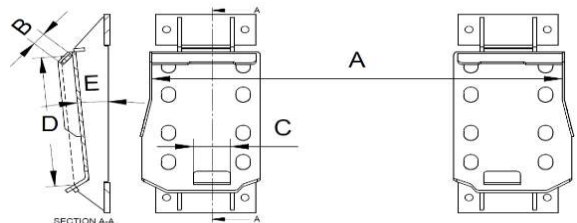

According SS-ISO24410:2020

Skid Steer Narrow					
Interface	No.	A (Inner)	B (Ø)	C (Ø)	D (C-C)
40x80/80x80	11256076X	903 mm	32 mm	85 mm	422 mm
M16 S	11256728X	35.5 in	1.26 in	3.3 in	16.61 in

According SS-ISO24410:2020

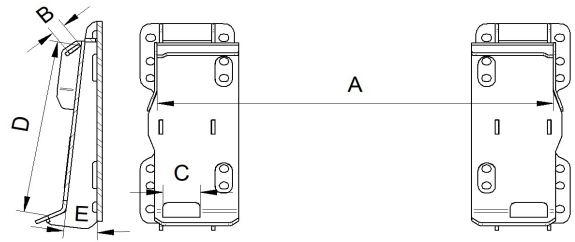

SMS					
Interface	No.	A (C-C)	B (Ø)	C (Ø)	D (C-C)
Rail	11254099X	690 mm 27.17 in	62 mm 2.44 in	32 mm 1.26 in	292 mm 11.50 in
Rail	11254223X				
40x80/80x80	11253940X				
80x80 XL					
M24	11255124X				
M16 S	11255579X				
M16 L	11255590X				
M16 S	11256667X*				

According SS 3527

* For Flexitrac machines

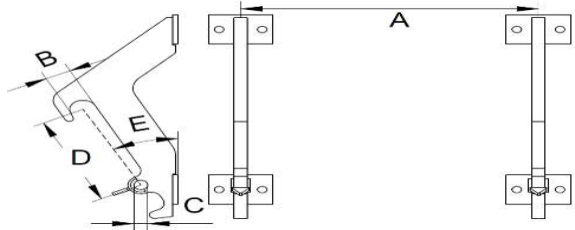

Terex/Schaeff/Yanmar					
Interface	No.	A (Inner)	B (Ø)	C (Ø)	D (C-C)
40x80/80x80	11256695X	935mm 36.8 in	50mm 2.0in	52mm 2.0in	500mm 19.7in
M24	11256697X				
M16	11256696X				

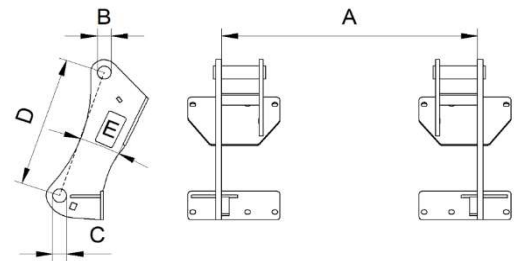

Volvo BM Large					
Interface	No.	A (C-C)	B (Ø)	C (Ø)	D (C-C)
Rail	11254147X	1000 mm 39.37 in	62 mm 2.44 in	52.4 mm 2.06 in	616 mm 24.25 in
40x80/80x80	11254149X				
80x80 XL	11255111X				
80x80 XL (High)	11255463X				
M24	11255354X				
M24 (High)	11255430X				
M24	11255310X				
M16 S					
M16 L	11255615X				

According SS-ISO 23727:2009

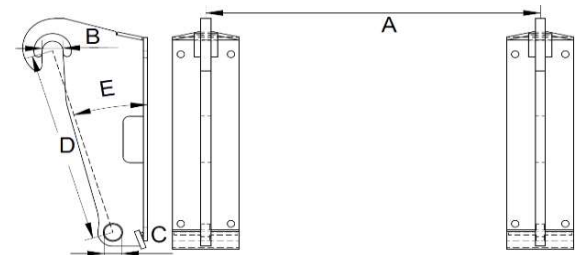

Volvo BM Small / Valtra					
Interface	No.	A (Inner)	B (Ø)	C (Ø)	D (C-C)
Rail	11254374X	985 mm 38.78 in	16 mm 0.63 in	33 mm 1.30 in	420 mm 16.53 in
40x80/80x80	11255145X				
80x80 XL					
M24					
M16 S					
M16 L					

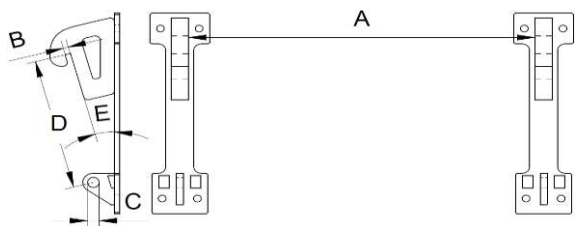

Weidemann					
Interface	No.	A (Inner)	B (Ø)	C (Ø)	D (C-C)
Rail	11254087X*	660 mm 25.98 in	41 mm 1.61 in	36 mm 1.41 in	321.5 mm 12.66 in
Rail	11254827X				
40x80/80x80	11255106X				
80x80 XL					
M24	11255264X				
M16 S	11255562X				
M16 L	11255586X				
M16 L	11255997X*				

*For wheel loaders with Z-Bar linkage

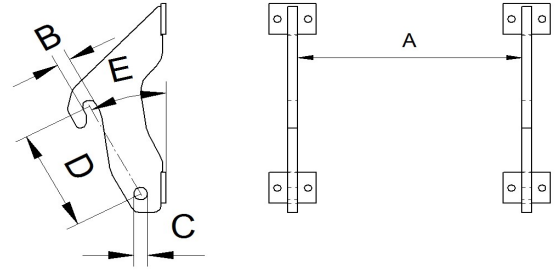

Weidemann 50-50					
Interface	No.	A (Inner)	B (Ø)	C (Ø)	D (C-C)
Rail	11255326X	845 mm 33.27 in	50.5 mm 1.99 in	51 mm 2.01 in	322 mm 12.68 in
40x80/80x80	11256226X				
80x80 XL	11255322X				
M24	11256305X				
M16 S					
M16 L	11255587X				

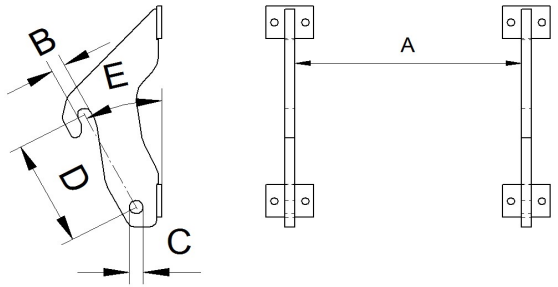

Weidemann MV					
Interface	No.	A (Inner)	B	C (Ø)	D
Rail		852 mm 33.5 in	22 mm 0.87 in	-	424 mm 16.68 in
40x80/80x80	11256113X				
80x80 XL					
M24					
M16 S	11256027X				
M16 L					

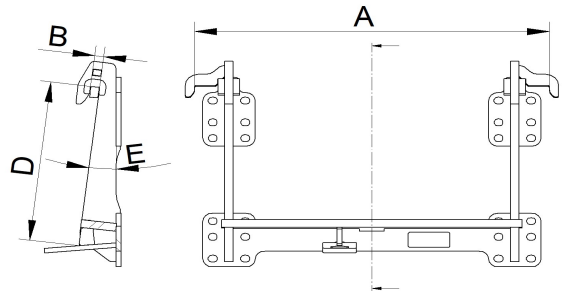

Zettelmeyer 402 / Volvo L20, L25					
Interface	No.	A (Inner)	B (Ø)	C (Ø)	D (C-C)
Rail	11254086X	650 mm 25.59 in	32 mm 1.26 in	42 mm 1.65 in	464 mm 18.27 in
40x80/80x80	11255139X				
80x80 XL					
M24					
M16 S					
M16 L	11255616X				

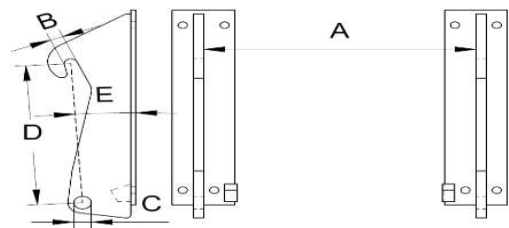

Zettelmeyer 602 / Volvo L30

Interface	No.	A (Inner)	B (Ø)	C (Ø)	D (C-C)
Rail	11254085X	862 mm 33.9 in	41 mm 1.61 in	42 mm 1.65 in	311.5 mm 12.26 in
Rail (Claas)	11256239X				
Rail (JCB)	11255510X				
40x80/80x80	11255500X				
40x80/80x80 (Claas)	11256254X				
40x80/80x80	11255429X				
40x80/80x80 (Claas)	11256253X				
40x80/80x80 (JCB)	11255498x				
80x80 XL	11255490X				
80x80 XL (JCB)	11255491X				
M24**	11255270X				
M24 (Claas)**	11256252X				
M24***	11256007X				
M24 (Claas)***	11256192X				
M24 (JCB)	11255470X				
M16 S					
M16 L	11255558X				
M16 L (Claas)	11256191X				
M16 L (Schäffer VL)	11256156X				
M16 L (JCB)	11255621X				

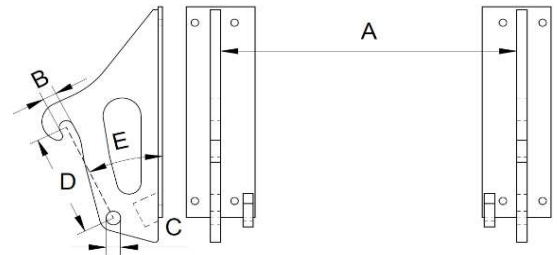

*Older JCB machines with Z-link use non JCB Bolt On Hook

**To be used with VL+ and GXL+ Buckets

***To be used with SL+ and GL+ Buckets

Älö 3

Interface	No.	A (C-C)	B (Ø)	C (Ø)	D (C-C)
Rail		916 mm 36.06 in	27 mm 1.06 in	30.5 mm 1.20 in	237 mm 9.33 in
40x80/80x80	11254509X				
80x80 XL					
M24					
M16 S					
M16 L	11255624X				

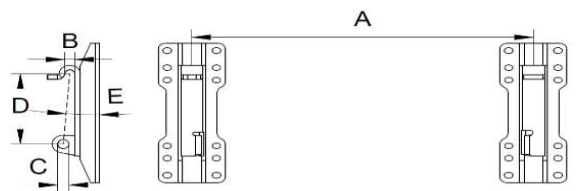

Älö HD

Interface	No.	A (C-C)	B (Ø)	C (Ø)	D (C-C)
Rail		1203 mm 47.36 in	41 mm 1.61 in	39 mm 1.53 in	309 mm 12.2 in
40x80/80x80					
80x80 XL					
M24	11255988X				
M16 S					
M16 L	11255989X				

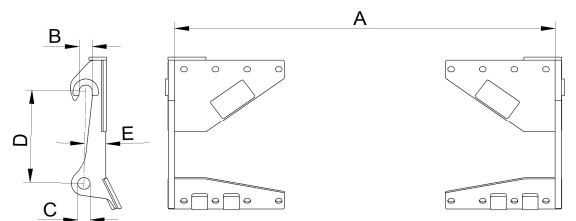

3-Point Linkage (Category 2/2N/3)					
Interface	No.	A (Inner)	B (Ø)	C (Ø)	D (C-C)
Rail					
40x80/80x80	11254879X				
80x80 XL	11255325X	830/965 mm 32.7/38 in	25/31.5 mm 1/1.25 in	28/36.5 mm 1.1/1.44 in	610/685 mm 24/27 in
M24					
M16 S					
M16 L					

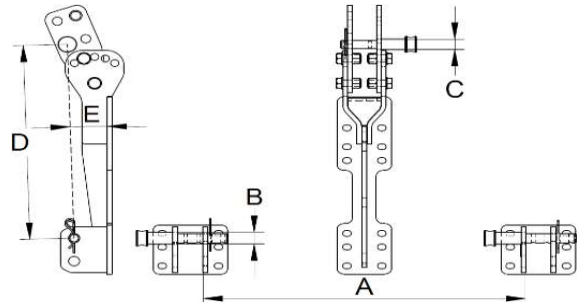

*** Dieci hook specification**

Dieci Small	Apollo 25.6 Mini Agri 25.6 Agri Pivot T40 Agri Pivot T50 Agri Pivot T60
Dieci Medium	Dadalus / Agri Farmer 28.7 Dadalus / Agri Farmer 30.7 Dadalus / Agri Farmer 32.6 Dadalus / Agri Farmer 28.9 Dadalus / Agri Farmer 30.9 Dadalus / Agri Farmer 28.7 VS Dadalus / Agri Farmer 30.7 VS Dadalus / Agri Farmer 28.9 VS Dadalus / Agri Farmer 30.9 VS Zeus / Agri Star 37.7 Zeus / Agri Star 37.8 Zeus / Agri Star 38.10 Zeus 33.11 Agri Tech 32.9 VS EVO 2 Agri Tech 35.7 VS EVO 2 Agri Plus 40.7 PS Agri Plus 40.7 VS EVO 2 Agri Plus 38.9 PS Agri Plus 38.9 VS EVO 2 Agri Pivot T70 Agri Pivot T80
Dieci Large	Samson 45.8 Runner 35.7 Runner 40.13 Icaros 40.14 Icaros 40.17 Pegasus 38.16 400° Pegasus 40.18 400° Pegasus 40.25 Pegasus 50.19 Pegasus 50.21 Pegasus 40.25